

Version: A1.2

Features

1. High light quality;
2. SDCM<3;
3. High CRI @ R9>90;
4. Mini cut unit, can be combined with profiles;

Application

Suitable for indoor shelves, display racks, and store decorative lighting, etc.

Installation

Fix by adhesive tape

Color tolerance

3000K

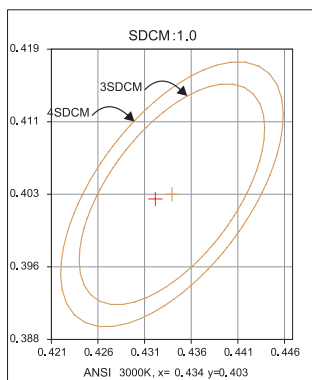

4000K

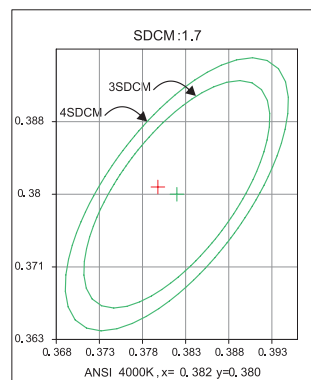

6500K

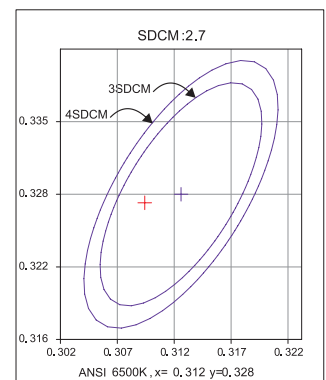

Note: The above data is the measured values of BVD1-128; For more information, please contact the sales rep.



Color Rendering Index

CCT=3073K (Duv=0.0002)		λd=582.5nm		Purity=50.6%		Ra=94.0		CRI=91.1
R1 =95	R2 =97	R3 =97	R4 =94	R5 =93	R6 =95	R7 =94		
R8 =87	R9 =93	R10=91	R11=94	R12=77	R13=95	R14=97	R15=92	

CCT=4053K (Duv=0.0020)		λd=577.8nm		Purity=28.1%		Ra=94.2		CRI=91.2
R1 =95	R2 =97	R3 =98	R4 =92	R5 =93	R6 =94	R7 =95		
R8 =89	R9 =92	R10=92	R11=93	R12=68	R13=96	R14=98	R15=92	

CCT=6683K (Duv=0.0043)		λd=488.6nm		Purity=8.6%		Ra=93.9		CRI=92.8
R1 =97	R2 =96	R3 =96	R4 =90	R5 =94	R6 =96	R7 =91		
R8 =92	R9 =97	R10=93	R11=95	R12=69	R13=97	R14=98	R15=93	

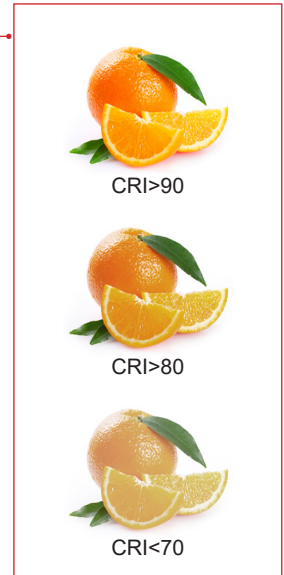

R9

R9 is the color rendering index of a light source for saturated red. A light source with a high R9 value can render red perfectly. Fruits and flowers usually use light sources with high R9 values.

Note: The above data is the measured values of BVD1-128; For more information, please contact the sales rep.

Color Fidelity Index And Color Gamut

Rf: Color Fidelity Index, Rf values in the range 0-100, the higher value means a perfect source, the lower value means a source that does not render colors correctly at all in comparison to the reference source.

Rg: Color Gamut, as a measure of color gamut and an indicator of changes in color saturation.



3000K

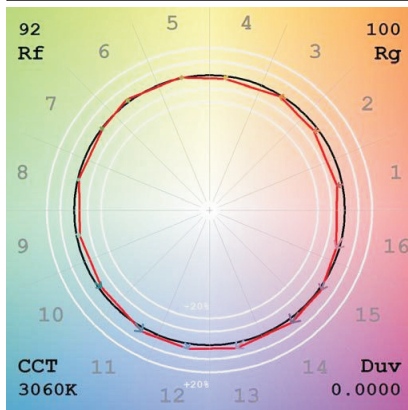
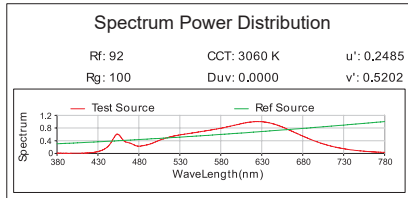

4000K

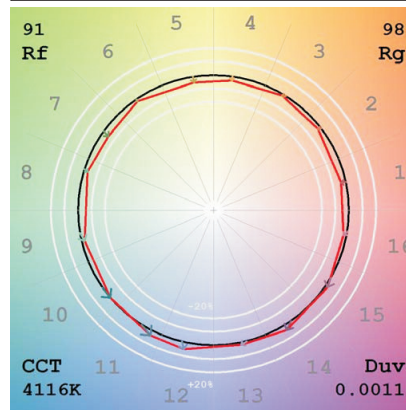
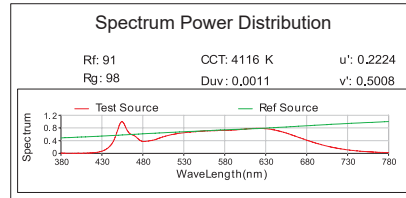

6500K

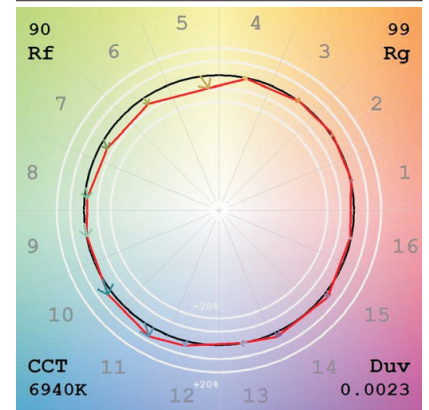
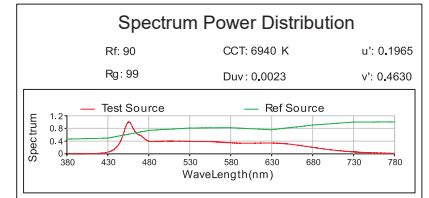

Specification

Model No.	Light Color	Color Temperature(K)	Beam Angle	Measured Luminous Flux (lm/pcs)	Ra	Efficacy (lm/W)	Voltage (V DC)	Power (W/pcs)
BVD1-128	W	3000	120°	1279	90+	116	24	11.5
		4000		1393		126		
		6500		1212		116		
BVD2-144	W	3000	120°	1523	90+	116	24	13.0
		4000		1611		124		
		6500		1534		115		
BVD3-176	W	3000	120°	1726	90+	116	24	15.8
		4000		1804		123		
		6500		1695		115		

Other Parameters

Model No.	Quantity (LED Qty/pc)	Product Size L*W*H(mm)	Standard Run(pcs)	Working Temperature	Storage Temperature
BVD1-128	128	1000*12*1.0	5	-20~+60°C	-20~+70°C
BVD2-144	144		4		
BVD3-176	176		2		

NOTE:

1. Testing temperature: 25±2°C
2. The above data are typical values. The actual data of each single product may differ from the typical values. The data is subject to change without notice.
3. Luminous flux is the measured value.
4. Different color temperature will make luminous flux different
5. Luminous flux & power tolerance within ±10%

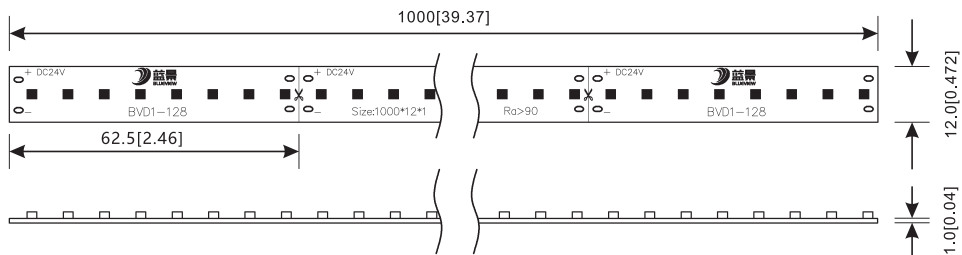
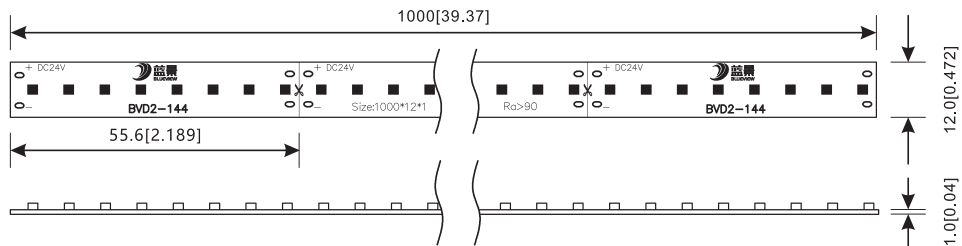
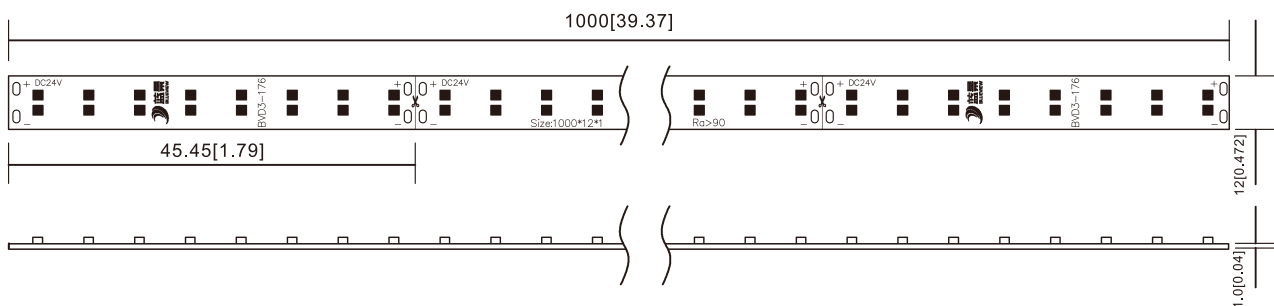
Profile Drawings
Unit:mm[inch]
BVD1-128

BVD2-144

BVD3-176

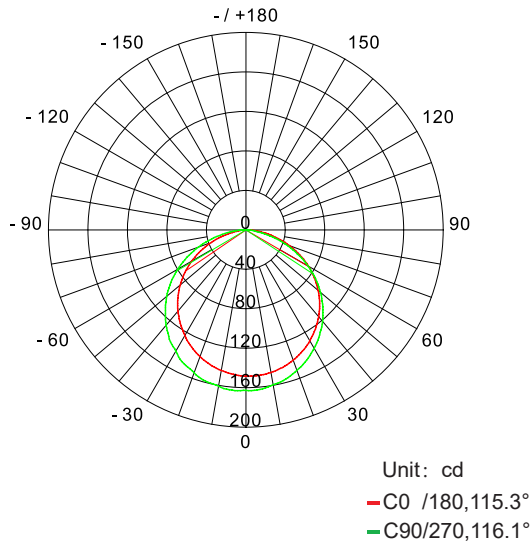
Luminous Intensity Distribution Diagram

Average Illumination

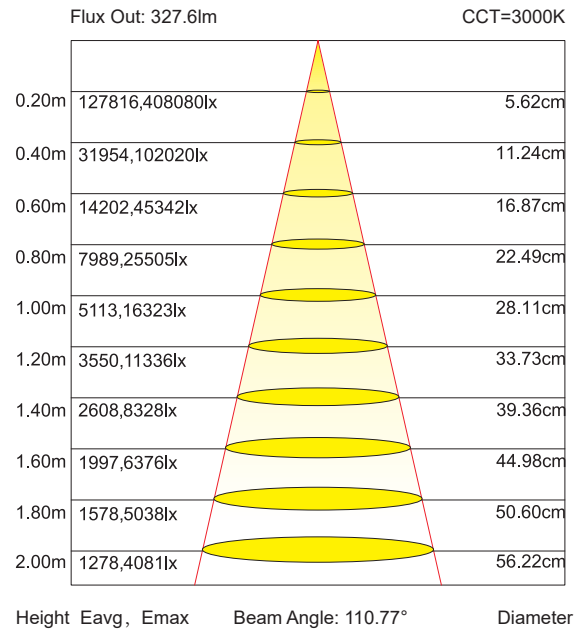

AVERAGE BEAM ANGLE(50%): 115.7°



Note:the above two figures are tested with the sample BVD1-128 of 3000K,for other data,please consult sale rep.

packing

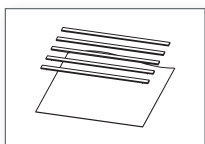

Put products on the pearl foam evenly

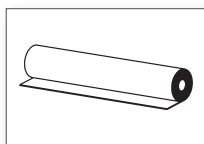

Wrap these products

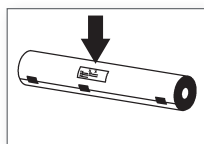

Seal both ends and stick a label

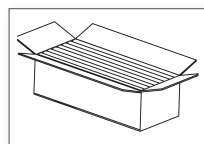

Put products into a carton

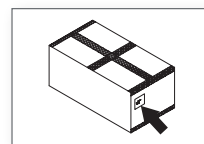

Seal and label the carton;

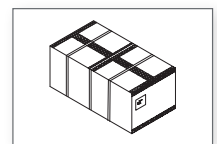

Use packing belt to pack

Packaging information

Model No.	Product Size L*W(mm)	Carton Size(mm)	pcs/carton	Net Weight(kg)	Gross Weight(kg)
BVD1-128	1000*12.0*1.0	1100*185*185	100	--(1±10%)	--(1±10%)
BVD2-144					
BVD3-176					

Note:the above quantity and weight are only for the illustrated packaging method. There will be differences in the quantity and weight with other packaging methods.

Installation

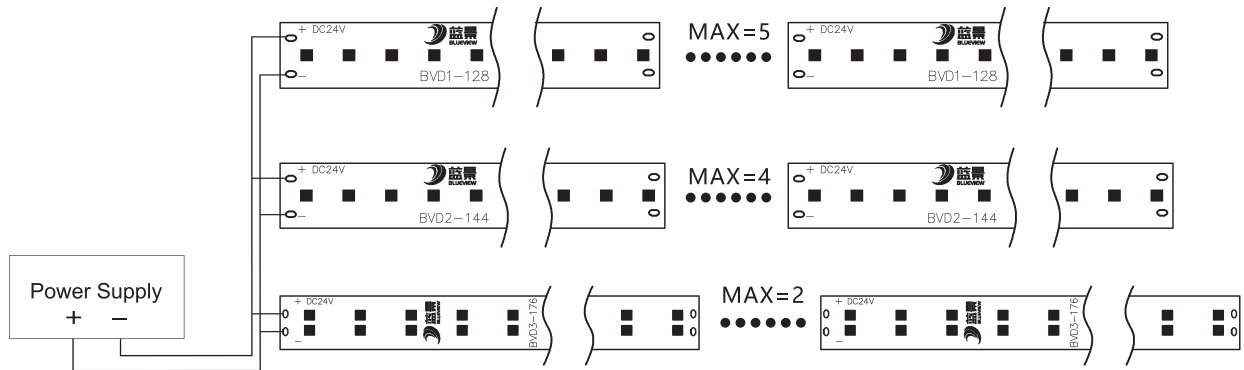

Installation steps

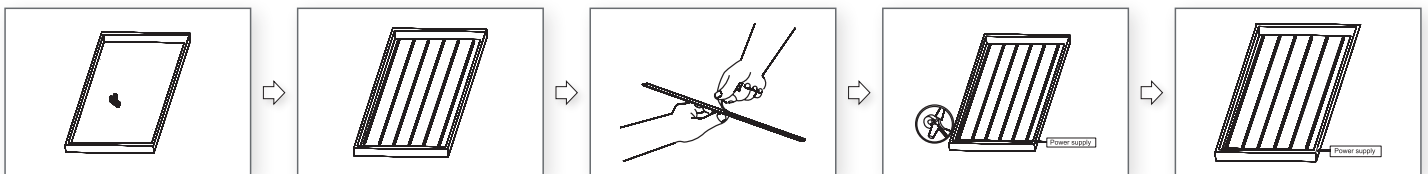

1. Clean the mounting surface.
2. Fix the installation spacing.
3. Peel away the self adhesive tape on the back of product and mount it onto the lightbox bottom.
4. Connect the bare wires with connection terminals, and the wire ends shall be well insulated, waterproof and anti-corrosion.
5. Fix the product with screws, then power on to test.



Attentions before installation

- Before installation, check that the product parameters are consistent with the requirements (Seeing product specifications or product labels)
- Load voltage, current, power and power supply should be matched with the product.
- Follow the instructions of wiring diagram (first connect the load and then the power supply) to avoid short circuit.
- Make sure the correct connection of positive and negative poles between products and power supply. Otherwise, the light will not be on.
- Make sure the power cord firmly screwed into the terminal and it should not be pulled out by hands.
- The terminal should have insulation, waterproof and anti-corrosive treatment.

Common Faults and Troubleshoot

Quick Guide		
Problems	Reasons	Solutions
All LEDs can not light on.	No electric supply.	Fix the short circuit problem.
	Automatic power protection from the open or short circuit in output of the power supply.	
	Wrong connection of power supply.	
LEDs can not light on partly.	Some switching mode power supplies are not powered.	Correctly connection.
	Power supply line error.	
	Mistaken wire connection of some of products	
Brightness of LED is inconsistent tor insufficient.	Power overloaded.	Replace with more powerful power.
	Power supply circuit excessive consumption.	Make sure the working voltage of the product within $\pm 5\%$ of standard voltage, or keep balance by circuit power consumption.
	Excessive quantities in series connection of the product	Reduce the quantities of the product in series connection to meet requirement.
LED flicker.	Connection point fault.	Remove bad connection point.
	Switching power supply failure.	Replace a new power supply.
	Wrong Installation or use of products	Please follow the instructions

Warning

- Do not disassemble or retrofit the light. Do not touch the surface of the light with a sharp object.
- Do not do live-line working during installation, especially for high voltage product.
- Do not use any organic chemical solvents.
- Use neutral glass adhesive to fix this product and it needs to be dried 4 hours in the open environment after operation.
- Treat the ends and the circuit connection points that are not connected to the main line with insulation, waterproof, and anti-corrosion in the installation.
- Use 18AWG (0.75mm² cross-sectional area) or thicker core wire to avoid adverse consequences caused by overheating, if the power cable need to lengthen.
- Make sure the input voltage meets the requirements and lines are connected correctly before lighting on.
- This product is for signage, and do not use as general lighting.
- Series connection within the max run.
- The length of the power cable between the power supply and the led strip should not exceed 2 meters. Otherwise, large circuit loss will lead to inconsistent brightness.
- Installation, maintenance and repair should be operated by a qualified technician.

Statements and Recycling

Statements:

- Repair should be operated by a qualified technician, if the external circuit or main line of this product is damaged.
- The parameters given in this manual are typical values and for reference only.
- All illustrations and drawings in this manual are for reference.
- This product is subject to change without notice.

Recycling:

- LED lighting products belongs to electronic products, please do recycling treatment according to the relevant WEEE directives.